



# 4-WAY TOGGLE VALVES

## 4-Way Toggle Valves

4-way valves can supply and exhaust two different outlets, and are commonly used with double-acting cylinders. When the toggle is in one position air flows from the inlet to one of the outlets. The second outlet is open to the exhaust port which is vented to atmosphere. Moving the toggle to the opposite position opens the inlet to the second outlet

while exhausting the first outlet. 4-way toggle valves are spool valves that by movement of the toggle may either be 2-position or have a momentary actuation.

**Medium:** Air

**Stem Travel:** 1/8" (3.2)

**Materials:** Brass body, Buna-N seals, stainless steel stem and spring

**Mounting:** 15/32-32 thread. Nuts and lockwashers furnished.

### 2 Position Spool Valves

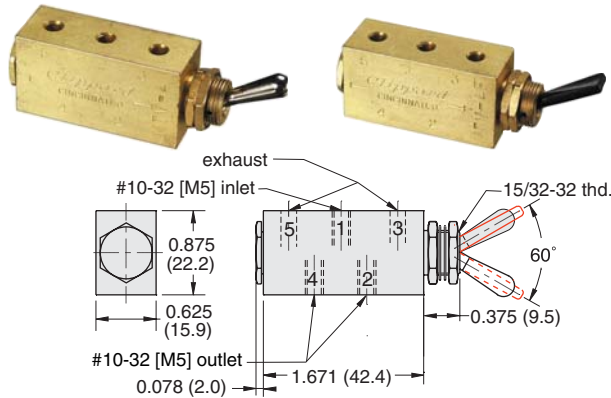

**Input Pressure:** 150 psig/10 bar max.

**Air Flow:** 6 scfm @ 50 psig; 10 scfm @ 100 psig;  
240 l/min @ 6 bar

**Force For Full Stem Travel:** 12 oz. nominal

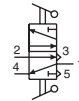

Part No.	Description
<a href="#">MTV-4</a>	2 Position Spool Valve, NP Steel Toggle, #10-32
<a href="#">MTV-4-M5</a>	2 Position Spool Valve, NP Steel Toggle, M5
<a href="#">MTV-4F</a>	2 Position Spool Valve, Plastic Toggle, #10-32
<a href="#">MTV-4F-M5</a>	2 Position Spool Valve, Plastic Toggle, M5

### J-Series 2 Position Spool Valves

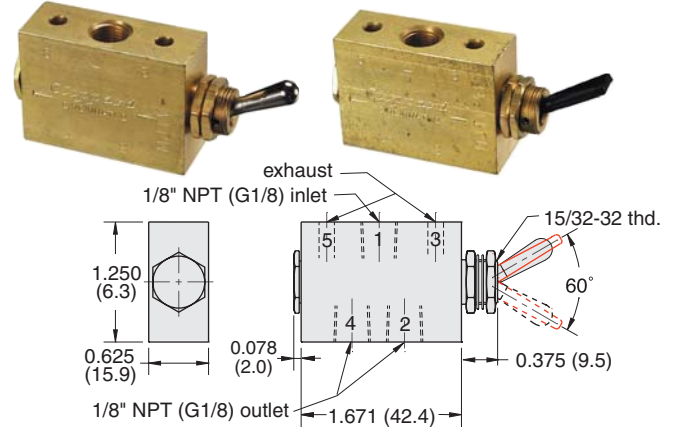

**Input Pressure:** 150 psig/10 bar max.

**Air Flow:** 6.5 scfm @ 50 psig; 10.5 scfm @ 100 psig;  
250 l/min @ 6 bar

**Force For Full Stem Travel:** 12 oz. nominal

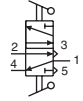

Part No.	Description
<a href="#">MITV-4</a>	2 Position Spool Valve, NP Steel Toggle, 1/8" NPT
<a href="#">MJTV-4-MG</a>	2 Position Spool Valve, NP Steel Toggle, G1/8
<a href="#">MITV-4F</a>	2 Position Spool Valve, Plastic Toggle, 1/8" NPT
<a href="#">MJTV-4F-MG</a>	2 Position Spool Valve, Plastic Toggle, G1/8

### 2 Position Fully-Ported Spool Valves

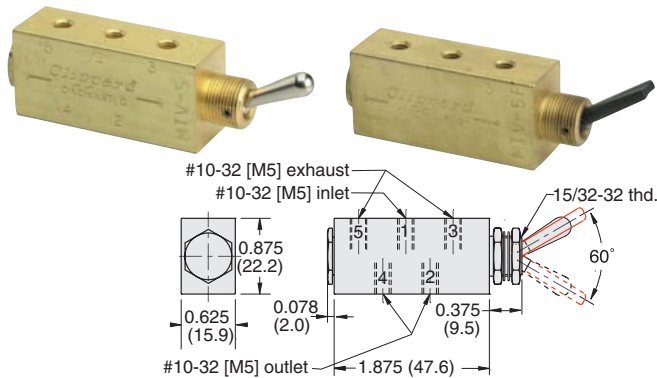

**Input Pressure:** 150 psig/10 bar max.

**Air Flow:** 6 scfm @ 50 psig; 10 scfm @ 100 psig;  
240 l/min @ 6 bar

**Force For Full Stem Travel:** 16 oz. nominal

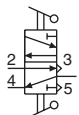

Part No.	Description
<a href="#">MTV-5</a>	2 Position Spool Valve, NP Steel Toggle, #10-32
<a href="#">MTV-5-M5</a>	2 Position Spool Valve, NP Steel Toggle, M5
<a href="#">MTV-5F</a>	2 Position Spool Valve, Plastic Toggle, #10-32
<a href="#">MTV-5F-M5</a>	2 Position Spool Valve, Plastic Toggle, M5

### J-Series 2 Position Fully-Ported Spool

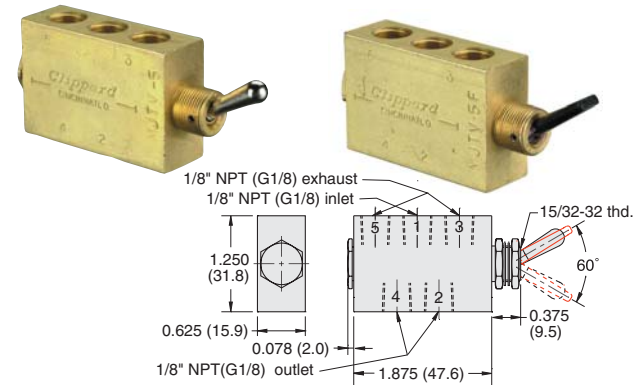

**Input Pressure:** 150 psig/10 bar max.

**Air Flow:** 6.5 scfm @ 50 psig; 10.5 scfm @ 100 psig;  
250 l/min @ 6 bar

**Force For Full Stem Travel:** 16 oz. nominal

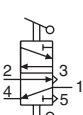

Part No.	Description
<a href="#">MJTV-5</a>	2 Position Spool Valve, NP Steel Toggle, 1/8" NPT
<a href="#">MJTV-5-MG</a>	2 Position Spool Valve, NP Steel Toggle, G1/8
<a href="#">MJTV-5F</a>	2 Position Spool Valve, Plastic Toggle, 1/8" NPT
<a href="#">MJTV-5F-MG</a>	2 Position Spool Valve, Plastic Toggle, G1/8